

spirax sarco

LCV3, LCV4, LCV6 and LCV7 Lift Check Valves

Description

The LCV3, LCV4, LCV6 and LCV7 lift check valves are designed in accordance with EN 12516 and **ASME B16.34** to prevent reverse flow in horizontal pipeline installations. The design of these valves allows them to be easily serviced without removing the valve from the pipeline - See Spare parts.

Available types:

LCV3 Cast iron bodied with stainless steel internals.

LCV4 Cast steel bodied with stainless steel internals.

LCV6 Stainless steel bodied with stainless steel internals.

LCV7 SG iron bodied with stainless steel internals.

Optional for the LCV4:

High temperature bolting (stainless steel A2-70).

Standards

These products fully comply with the requirements of the European Pressure Equipment Directive 97/23/EC and carries the **CE** mark when so required.

Standard shut-off

This range of lift check valves conform to EN 12266-1: 2003 Rate F.

Certification

With the exception of the LCV3 these products are available with certification to EN 10204 3.1. **Note:** All certification / inspection requirements must be stated at the time of order placement.

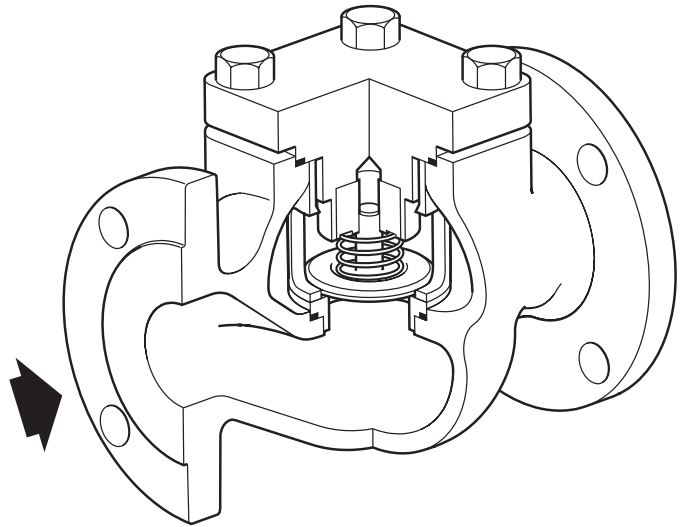

Sizes and pipe connections

Unit	LCV3			LCV4			LCV6			LCV7		
	PN16 JIS/KS 10	ASME 125	BSP NPT	PN40 JIS/KS 20	ASME 150 ASME 300	NPT SW	PN40 JIS/KS 20	ASME 150 ASME 300	BSP NPT SW	PN16 PN25 JIS/KS 10	ASME 125 ASME 250	BSP NPT
DN15 1/2"	•		•	•	•	•	•	•	•	•		•
DN20 3/4"	•		•	•	•	•	•	•	•	•		•
DN25 1"	•	•	•	•	•	•	•	•	•	•	•	•
DN32 1 1/4"	•		•	•		•	•		•	•		•
DN40 1 1/2"	•	•	•	•	•	•	•	•	•	•	•	•
DN50 2"	•	•	•	•	•	•	•	•	•	•	•	•
DN65 2 1/2"	•	•		•	•		•	•		•	•	
DN80 3"	•	•		•	•		•	•		•	•	
DN100 4"	•	•		•	•		•	•		•	•	

Local regulation may restrict the use of this product below the conditions quoted. Limiting conditions refer to standard connections only.
In the interests of development and improvement of the product, we reserve the right to change the specification.

TI-P029-16-US 04.11

LCV3, LCV4, LCV6 and LCV7 Lift Check Valves

LCV3 pressure / temperature limits

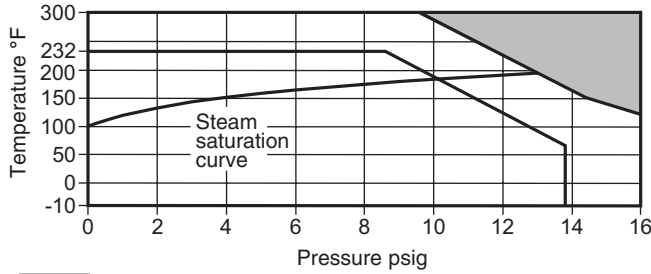

 The product **must not** be used in this region.

- A - B** Screwed BSP and flanged EN 1092 PN16.
C - D Screwed NPT, socket weld and flanged ASME 125.

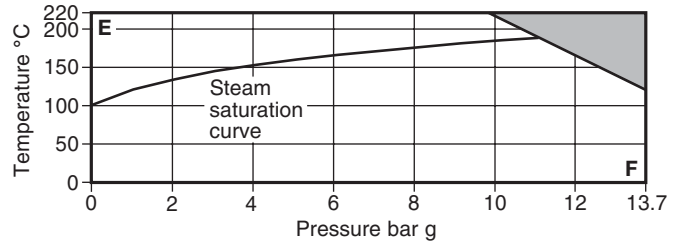

 The product **must not** be used in this region.

- E - F** Flanged JIS / KS 10.

Screwed and Flanged EN 1092 PN16	Body design conditions	PN16
	PMA Maximum allowable pressure	16 bar g @ 120°C
	TMA Maximum allowable temperature	300°C @ 9.6 bar g
	Minimum allowable temperature	-10°C
	PMO Maximum operating pressure for saturated steam service	13 bar g
	TMO Maximum operating temperature	300°C @ 9.6 bar g
	Minimum operating temperature	-10°C
Note: For lower operating temperatures consult Spirax Sarco.		
Designed for a maximum cold hydraulic test pressure of:		24 bar g
Flanged ASME 125	Body design conditions	ASME 125
	PMA Maximum allowable pressure	200 psi g @ 149°F
	TMA Maximum allowable temperature	449°F @ 125 psi g
	Minimum allowable temperature	14°F
	PMO Maximum operating pressure for saturated steam service	145 psi g
	TMO Maximum operating temperature	449°F @ 125 psi g
	Minimum operating temperature	14°F
Note: For lower operating temperatures consult Spirax Sarco.		
Designed for a maximum cold hydraulic test pressure of:		297 psi g
Flanged JIS / KS 10	Body design conditions	JIS / KS 10
	PMA Maximum allowable pressure	13.7 bar g @ 120°C
	TMA Maximum allowable temperature	220°C @ 9.8 bar g
	Minimum allowable temperature	0°C
	PMO Maximum operating pressure for saturated steam service	11.2 bar g
	TMO Maximum operating temperature	220°C @ 9.8 bar g
	Minimum operating temperature	0°C
Note: For lower operating temperatures consult Spirax Sarco.		
Designed for a maximum cold hydraulic test pressure of:		20 bar g

LCV3, LCV4, LCV6 and LCV7 Lift Check Valves

LCV4 pressure / temperature limits

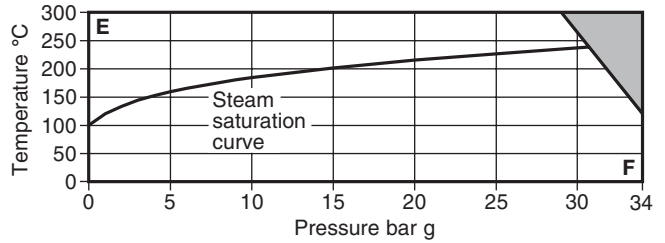
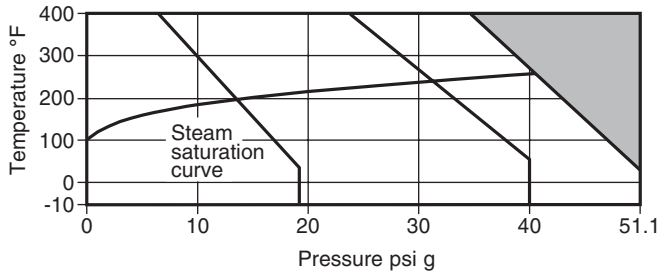

 The product **must not** be used in this region.

 The product **must not** be used in this region.

- A - B Screwed NPT, socket weld and flanged ASME 300.
- A - C Flanged EN 1092 PN40.
- A - D Flanged ASME 150.

- E - F Flanged JIS / KS 20.

Flanged EN 1092 PN40	Body design conditions	PN40
	PMA Maximum allowable pressure	40 bar g @ 50°C
	TMA Maximum allowable temperature	300°C @ 27.6 bar g
	Maximum allowable temperature with high temperature bolting	400°C @ 23.8 bar g
	Minimum allowable temperature	-10°C
	PMO Maximum operating pressure for saturated steam service	31.1 bar g
	TMO Maximum operating temperature	300°C @ 27.6 bar g
	Maximum operating temperature with high temperature bolting	400°C @ 23.8 bar g
	Minimum operating temperature	-10°C
	Note: For lower operating temperatures consult Spirax Sarco.	
Designed for a maximum cold hydraulic test pressure of:	60 bar g	
Flanged ASME 150	Body design conditions	ASME 150
	PMA Maximum allowable pressure	280 psi g @ 100°F
	TMA Maximum allowable temperature	572°F @ 148 psi g
	Maximum allowable temperature with high temperature bolting	752°F @ 94 psi g
	Minimum allowable temperature	14°F
	PMO Maximum operating pressure for saturated steam service	202 psi g
	TMO Maximum operating temperature	572°F @ 148 psi g
	Maximum operating temperature with high temperature bolting	752°F @ 94 psi g
	Minimum operating temperature	14°F
	Note: For lower operating temperatures consult Spirax Sarco.	
Designed for a maximum cold hydraulic test pressure of:	435 psi g	
Screwed NPT Socket weld and Flanged ASME 300	Body design conditions	ASME 300
	PMA Maximum allowable pressure	741 psi g @ 100°F
	TMA Maximum allowable temperature	572°F @ 577 psi g
	Maximum allowable temperature with high temperature bolting	752°F @ 503 psi g
	Minimum allowable temperature	14°F
	PMO Maximum operating pressure for saturated steam service	606 psi g
	TMO Maximum operating temperature	572°F @ 577 psi g
	Maximum operating temperature with high temperature bolting	752°F @ 503 psi g
	Minimum operating temperature	14°F
	Note: For lower operating temperatures consult Spirax Sarco.	
Designed for a maximum cold hydraulic test pressure of:	1117 psi g	
Flanged JIS / KS 20	Body design conditions	JIS / KS 20
	PMA Maximum allowable pressure	34 bar g @ 120°C
	TMA Maximum allowable temperature	300°C @ 32 bar g
	Minimum allowable temperature	0°C
	PMO Maximum operating pressure for saturated steam service	30 bar g
	TMO Maximum operating temperature	300°C @ 32 bar g
	Minimum operating temperature	0°C
	Note: For lower operating temperatures consult Spirax Sarco.	
	Designed for a maximum cold hydraulic test pressure of:	51 bar g

LCV3, LCV4, LCV6 and LCV7 Lift Check Valves

LCV6 pressure / temperature limits

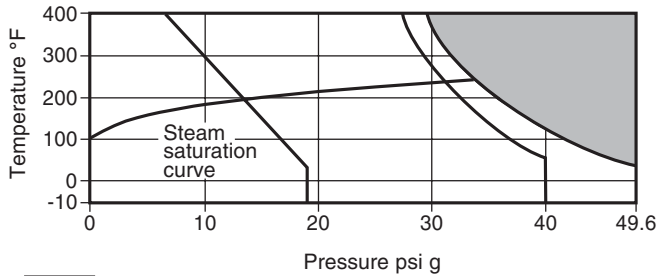

 The product **must not** be used in this region.

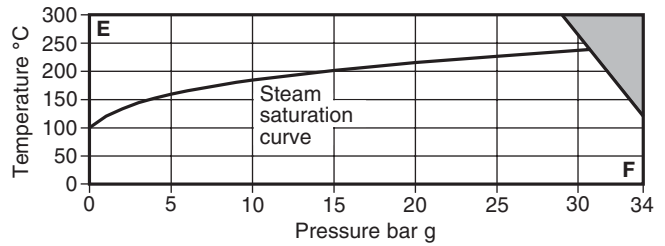

 The product **must not** be used in this region.

- A - B Screwed NPT, socket weld and flanged ASME 300.
- A - C Screwed BSP and flanged EN 1092 PN40.
- A - D Flanged ASME 150.

- E - F Flanged JIS / KS 20.

Screwed BSP and Flanged EN 1092 PN40	Body design conditions	PN40
	PMA Maximum allowable pressure	40 bar g @ 50°C
	TMA Maximum allowable temperature	400°C @ 27.4 bar g
	Minimum allowable temperature	-10°C
	PMO Maximum operating pressure for saturated steam service	32.3 bar g
	TMO Maximum operating temperature	400°C @ 27.4 bar g
	Minimum operating temperature	-10°C
Note: For lower operating temperatures consult Spirax Sarco.		
Designed for a maximum cold hydraulic test pressure of:		60 bar g
Screwed NPT Socket weld and Flanged ASME 300	Body design conditions	ASME 300
	PMA Maximum allowable pressure	720 psi g @ 100°F
	TMA Maximum allowable temperature	752°F @ 426 psi g
	Minimum allowable temperature	14°F
	PMO Maximum operating pressure for saturated steam service	493 psi g
	TMO Maximum operating temperature	752°F @ 426 psi g
	Minimum operating temperature	14°F
Note: For lower operating temperatures consult Spirax Sarco.		
Designed for a maximum cold hydraulic test pressure of:		1102 psi g
Flanged ASME 150	Body design conditions	ASME 150
	PMA Maximum allowable pressure	276 psi g @ 100°F
	TMA Maximum allowable temperature	752°F @ 94 psi g
	Minimum allowable temperature	14°F
	PMO Maximum operating pressure for saturated steam service	200 psi g
	TMO Maximum operating temperature	752°F @ 94 psi g
	Minimum operating temperature	14°F
Note: For lower operating temperatures consult Spirax Sarco.		
Designed for a maximum cold hydraulic test pressure of:		435 psi g
Flanged JIS / KS 20	Body design conditions	JIS / KS 20
	PMA Maximum allowable pressure	34 bar g @ 120°C
	TMA Maximum allowable temperature	300°C @ 32 bar g
	Minimum allowable temperature	0°C
	PMO Maximum operating pressure for saturated steam service	23.5 bar g
	TMO Maximum operating temperature	300°C @ 32 bar g
	Minimum operating temperature	0°C
Note: For lower operating temperatures consult Spirax Sarco.		
Designed for a maximum cold hydraulic test pressure of:		51 bar g

LCV3, LCV4, LCV6 and LCV7 Lift Check Valves

LCV7 pressure / temperature limits

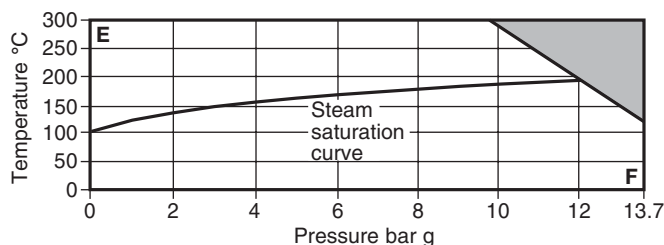
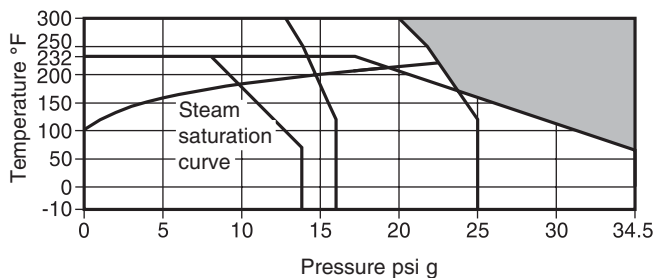

 The product **must not** be used in this region.

 The product **must not** be used in this region.

A - B Screwed BSP and flanged EN 1092 PN25.

A - C Screwed NPT and flanged EN 1092 PN16.

D - G Flanged ASME 250.

D - H Flanged ASME 125.

E - F Flanged JIS / KS 10.

Flanged EN 1092 PN16	Body design conditions	PN16
	PMA Maximum allowable pressure	16 bar g @ 120°C
	TMA Maximum allowable temperature	300°C @ 12.8 bar g
	Minimum allowable temperature	-10°C
	PMO Maximum operating pressure for saturated steam service	14.7 bar g
	TMO Maximum operating temperature	300°C @ 12.8 bar g
	Minimum operating temperature	-10°C
Note: For lower operating temperatures consult Spirax Sarco.		
Designed for a maximum cold hydraulic test pressure of:		24 bar g
Screwed BSP and Flanged EN 1092 PN25	Body design conditions	PN25
	PMA Maximum allowable pressure	25 bar g @ 120°C
	TMA Maximum allowable temperature	300°C @ 20 bar g
	Minimum allowable temperature	-10°C
	PMO Maximum operating pressure for saturated steam service	22.5 bar g
	TMO Maximum operating temperature	300°C @ 20 bar g
	Minimum operating temperature	-10°C
Note: For lower operating temperatures consult Spirax Sarco.		
Designed for a maximum cold hydraulic test pressure of:		38 bar g
Flanged ASME 125	Body design conditions	ASME 125
	PMA Maximum allowable pressure	200 psi g @ 149°F
	TMA Maximum allowable temperature	450°F @ 125 psi g
	Minimum allowable temperature	14°F
	PMO Maximum operating pressure for saturated steam service	145 psi g
	TMO Maximum operating temperature	450°F @ 125 psi g
	Minimum operating temperature	14°F
Note: For lower operating temperatures consult Spirax Sarco.		
Designed for a maximum cold hydraulic test pressure of:		297 psi g
Screwed NPT and Flanged ASME 250	Body design conditions	ASME 250
	PMA Maximum allowable pressure	500 psi g @ 149°F
	TMA Maximum allowable temperature	450°F @ 250 psi g
	Minimum allowable temperature	14°F
	PMO Maximum operating pressure for saturated steam service	281 psi g
	TMO Maximum operating temperature	450°F @ 250 psi g
	Minimum operating temperature	14°F
Note: For lower operating temperatures consult Spirax Sarco.		
Designed for a maximum cold hydraulic test pressure of:		754 psi g
Flanged JIS / KS 10	Body design conditions	JIS / KS 10
	PMA Maximum allowable pressure	13.7 bar g @ 120°C
	TMA Maximum allowable temperature	300°C @ 9.8 bar g
	Minimum allowable temperature	0°C
	PMO Maximum operating pressure for saturated steam service	12.3 bar g
	TMO Maximum operating temperature	300°C @ 9.8 bar g
	Minimum operating temperature	0°C
Note: For lower operating temperatures consult Spirax Sarco.		
Designed for a maximum cold hydraulic test pressure of:		20 bar g

LCV3, LCV4, LCV6 and LCV7 Lift Check Valves

Materials

Standard

No.	Part	Material	PN /BSP	ASME /NPT /SW
1 and 2	Body and cover	LCV3 ASME Cast iron body with SG iron cover	Cover (1) EN 1561 GJL250	ASTM A395
		PN SG iron body with cast iron cover	Body (2) EN 1563 GJS400-15	ASTMA126 Class B
		LCV4 Carbon steel	EN 10213 1.0619+N	ASTM A216 WCB
		LCV6 Stainless steel	EN 10213 1.4408	ASTM A351-CF8M
		LCV7 SG iron	EN 1563 GJS400-18LT	ASTM A395
3	Gasket	Reinforced exfoliated graphite	Graphite	Graphite
4 and 5	Seat and guide	LCV3 Stainless steel	431	431
		LCV4 Stainless steel	431	431
		LCV6 Stainless steel	316L	316L
		LCV7 Stainless steel	431	431
6	Disc	Stainless steel	316L	316L
7	Spring	Stainless steel	316 S 42	316 S 42
8	Bolt	LCV3 Cast steel	Grade 8.8	Grade 8.8
		LCV4 Cast steel	Grade 8.8	Grade 8.8
		LCV6 Stainless steel	A2-70	A2-70
		LCV7 Cast steel	Grade 8.8	Grade 8.8
9	Seat retainer	Stainless steel	316L	316L

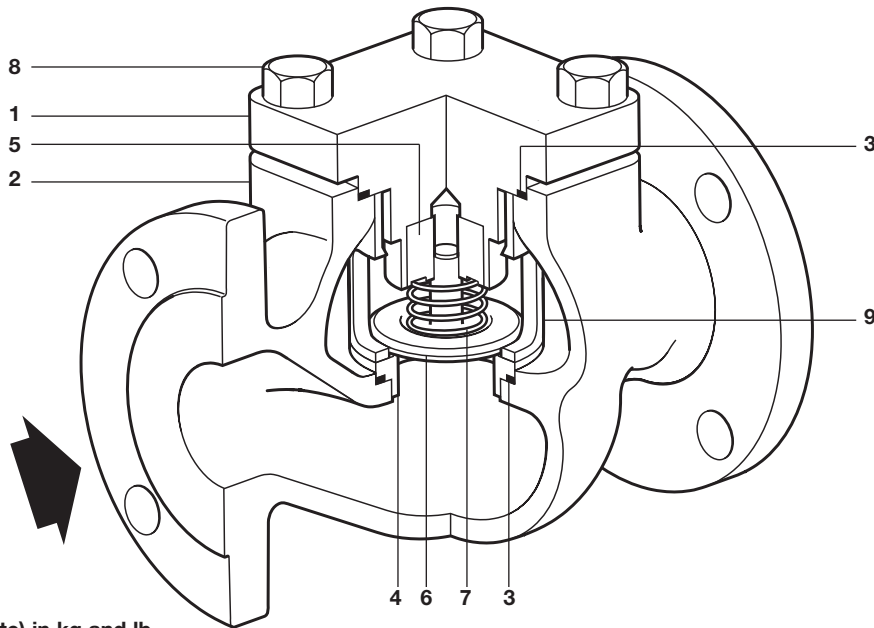

Weights (approximate) in kg and lb

Unit	LCV3				LCV4				LCV6				LCV7			
	Flanged		Screwed		Flanged		Screwed		Flanged		Screwed		Flanged		Screwed	
	kg	lb	kg	lb	kg	lb	kg	lb	kg	lb	kg	lb	kg	lb	kg	lb
DN15 ½"	4.30	9	3.10	7	5.05	11	3.65	8	5.19	11	3.79	8	4.64	10	3.24	7
DN20 ¾"	5.50	12	4.10	9	6.43	14	5.33	12	6.60	15	5.50	12	5.89	13	4.29	9
DN25 1"	5.82	13	4.10	9	6.58	15	4.18	9	6.77	15	4.37	10	6.04	13	3.74	8
DN32 1¼"	10.23	23	7.20	16	12.89	28	9.59	21	13.37	29	10.07	22	11.99	26	8.69	19
DN40 1½"	11.43	25	8.00	18	14.35	32	9.55	21	14.77	33	9.97	22	13.18	29	9.28	20
DN50 2"	14.96	33	10.50	23	16.86	37	12.06	27	17.51	39	12.71	28	15.65	35	10.65	23
DN65 2½"	27.04	60			32.25	71			33.13	73			29.53	65		
DN80 3"	29.47	65			36.02	79			37.00	82			33.00	73		
DN100 4"	48.93	108			52.06	115			53.47	118			48.82	108		

LCV3, LCV4, LCV6 and LCV7 Lift Check Valves

Dimensions (approximate) in mm

Please note: Flanged ASME versions are (approximate) in inches

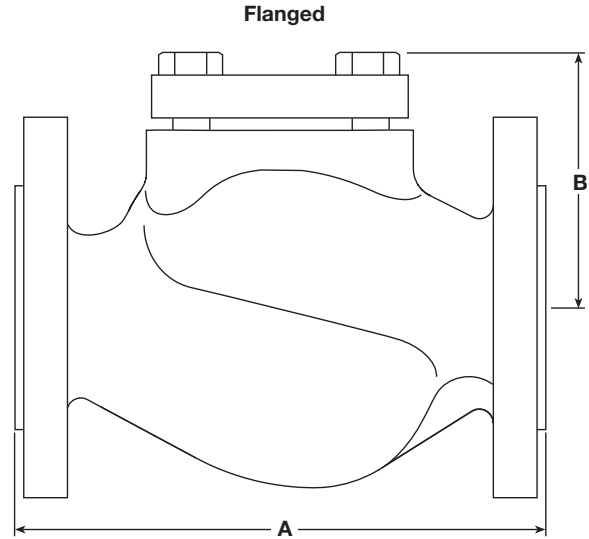
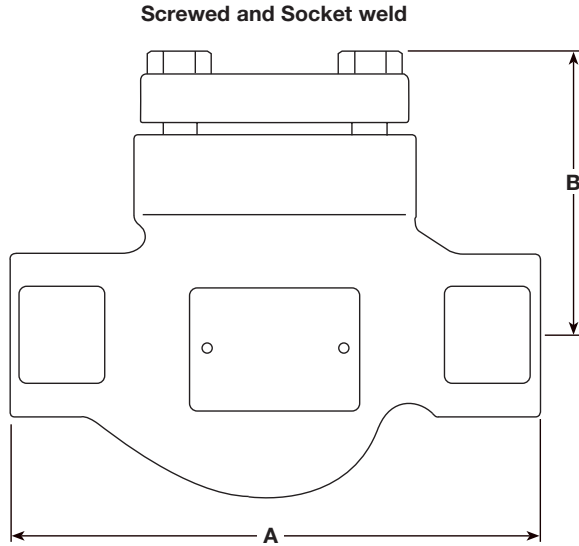

Dimension	Connection	Screwed	Flanged	Screwed	Flanged		Flanged
		BSP Socket weld	PN40 PN16 PN25 JIS 10/KS 10 JIS 20/KS 20	NPT	ASME 125 LCV3	LCV7	ASME 250 ASME 300
A	DN15 1/2"	130	130	6 1/2"	7 1/4"		7 1/2"
	DN20 3/4"	155	150	6 1/2"	7 1/4"		7 1/2"
	DN25 1"	160	160	7 3/4"	7 1/4"	7 1/4"	7 3/4"
	DN32 1 1/4"	185	180	8 1/2"			
	DN40 1 1/2"	205	200	9 1/4"	8 3/4"	8 3/4"	9 1/4"
	DN50 2"	230	230	10 1/2"	10"	10"	10 1/2"
	DN65 2 1/2"		290		10 1/2"	10 1/2"	11 1/2"
	DN80 3"		310		11 3/4"	11 3/4"	12 1/2"
	DN100 4"		350		13 3/4"	13 3/4"	14 1/2"
B	DN15 1/2"	88	88	4"	4"	4"	4"
	DN20 3/4"	88	88	4"	4"	4"	4"
	DN25 1"	88	88	4"	4"	4"	4"
	DN32 1 1/4"	117	117	5 3/16"			
	DN40 1 1/2"	117	117	5 3/16"	5 3/16"	5 3/16"	5 3/16"
	DN50 2"	117	117	5 3/16"	5 3/16"	5 3/16"	5 3/16"
	DN65 2 1/2"		166		7 7/8"	7 7/8"	7 7/8"
	DN80 3"		166		7 7/8"	7 7/8"	7 7/8"
	DN100 4"		180		8 1/2"	8 1/2"	8 1/2"

LCV3, LCV4, LCV6 and LCV7 Lift Check Valves

Capacities

	DN15 1/2"	DN20 3/4"	DN25 1"	DN32 1 1/4"	DN40 1 1/2"	DN50 2"	DN65 2 1/2"	DN80 3"	DN100 4"
K_v	5	8.3	11	18	34	42	87	113	135
CV (US)	5.9	9.7	12.9	21.1	39.8	49.1	101.8	132.2	158

Opening pressures in (mbar) and psi

Differential pressures with zero flow

Flow direction	DN15 to DN25	DN32 to DN50	DN65 to DN100
Horizontal	(22.5) 0.33	(24.5) 0.36	(25.5) 0.37
Vertical	(20) 0.30	(20) 0.29	(20) 0.29

Safety information, installation and maintenance

For full details see the Installation and Maintenance Instructions (IM-P029-17) supplied with the product.

Installation note:

Always install the lift check valve horizontally with the flow in the direction indicated on the body.

Disposal

These products are recyclable. No ecological hazard is anticipated with the disposal of these products, providing due care is taken.

How to order

Example: 1 off Spirax Sarco DN15 LCV4 lift check valve having flanged EN 1092 PN40 connections.

Spare parts

The spare parts available are shown in solid outline. Parts drawn in broken line are not supplied as spares.

Available spares



LCV Gaskets kit (Cover gasket and seat gasket)	Spare 1
LCV Internals kit (Cover gasket, seat gasket, spring, disc and seat)	Spare 2

How to order spares

Always order spares by using the description given in the column headed 'Available spares' and state the size and type of trap. Always order spares by using the description of the LCV and Spare 1 or Spare 2.

Example: 1 off LCV Internals kit – Spare 2, for a Spirax Sarco DN15 LCV4 lift check valve having flanged EN 1092 PN40 connections.

Recommended tightening torques

Item	Size					N m		
		EN	ASME	EN	ASME			
3	DN15 to DN25 (1/2" to 1")	LCV3	17 A/F	7/8" A/F	LCV3	M10	1/2" - 13 UNC	40 - 50
		Others	19 A/F		Others			
	DN32 to DN50 (1 1/4" to 2")	LCV3	19 A/F	1 1/16" A/F	LCV3	M12	5/8" - 11 UNC	80 - 90
		Others	24 A/F		Others			
	DN65 to DN80 (2 1/2" to 3")		24 A/F	1 1/4" A/F	M16	3/4" - 9 UNC	90 - 100	
	DN100 (4")		24 A/F	1 1/16" A/F	M16	5/8" - 11 UNC	70 - 80	

